

ITEM NO: M90079MBK
M90079TG
M90079WH

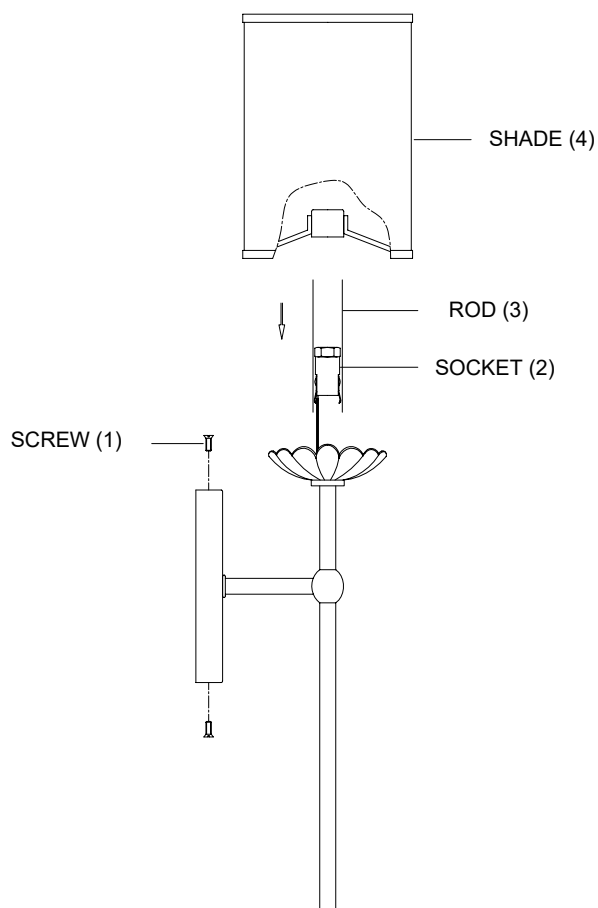

ASSEMBLY INSTRUCTIONS

1. Carefully unpack and identify all parts referring to illustration for parts identification.
2. Turn the power to the installation point OFF.
3. Install the shade (4) onto the rod (3).
4. Refer to the additional installation instructions included with the product for wiring and installation.
5. Install proper bulbs (not included) into each socket referring to the markings and/or labels on the fixture for maximum wattage.
6. Restore power to the installation point and retain this sheet for future reference.